

# LP 351640 Lithium Polymer Battery

## Brief Datasheet

### 1 BASIC SPECIFICATION

1	Battery Type	LP351640	
2	Nominal Capacity	Typical	180mAh (0.2C discharge)
		Minimum	170mAh (0.2C discharge)
3	Nominal Voltage	3.7V(0.2C discharge)	
4	Charging Voltage	4.2V±0.05V	
5	Standard Charge	Method: CC/CV (constant current/constant voltage) Current:85mA (0.5C) Voltage:4.2V EndCurrent:3.4mA (0.02C)	
6	Maximum Charge Current	170mA (1C)	
7	Standard Discharge	Method: CC (constant current) Current: 34mA (0.2C) End Voltage:2.75V	
8	Maximum Discharge Current	255mA (1.5C)	
9	Weight	Approx.3.9±0.5g	
10	Operating temperature	Charge: 0°C to 45°C Discharge: -20°C to 60°C	
11	Storage Temperature	-20°C to 45°C	
12	Cycle life	500cycles (at 0.5C charge and discharge, 23°C)	

Note: 1C = 1 x Capacity mA

### 2 MAIN FEATURES

- Thin format, light weight, large area, and flexibility in design.
- Easily customized, Energy density, High capacity.

### 3 WARNING

- Do not overcharge, force charge, short circuit, disassemble, deform, heat or place the battery near a direct flame. Any of the above actions could cause it to ignite, explode or become damaged.
- Keep this battery out of the reach of children.
- When storing the battery or throwing it away, be sure to cover with tape.

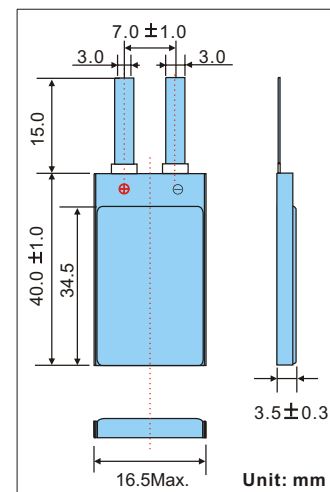

# Li-Polymer

Note: Any representations in this brochure concerning performance, are for informational purposes only and are not construed as warranties either expressed or implied, of future performance.