

LIR2477 *Brief Datasheet*

Lithium Ion Battery

1 Dimension

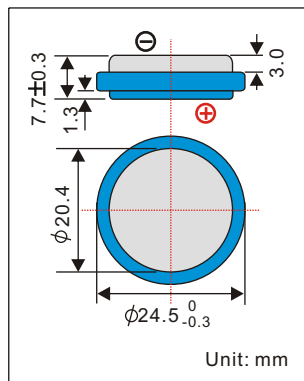

3 Electrical Characteristics

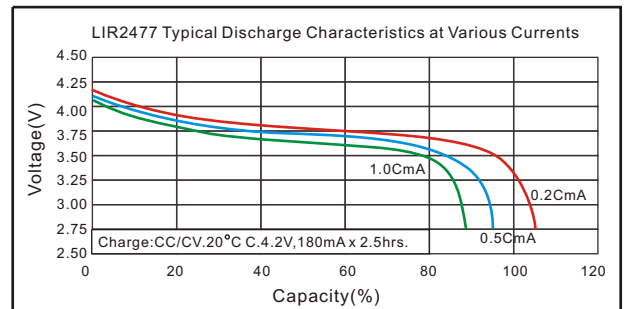

2 Basic Specification

Nominal Voltage	3.6V	
Nominal Capacity	Typical	160mAh
	Minimum	150mAh
Charge method	CC/CV (Constant Current-Constant Voltage) current:0.5C Voltage:4.2V End current:0.02C	
Charging Voltage	4.20V	
Charging Std. Current	0.5C	
Max Current	Charge	1C
	Discharge	2C
Ambient Temperature	Std. Charge	-20°C to 45°C
	Discharge	-20°C to 60°C
	Storage	-20°C to 60°C
Discharge cut-off voltage	2.75V	
Internal Impedance	≤200mΩ	
Cycle life	>500cycles(≥80% capacity)	
Nominal Weight	Approx.7.0g	

*1C = 1 Capacity

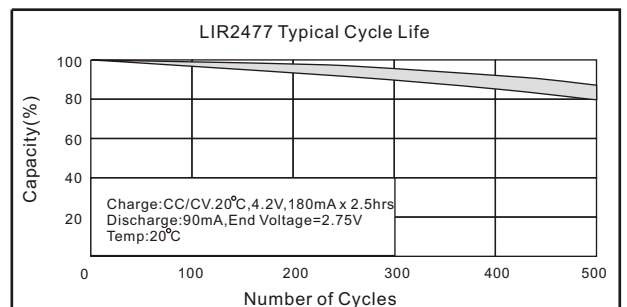
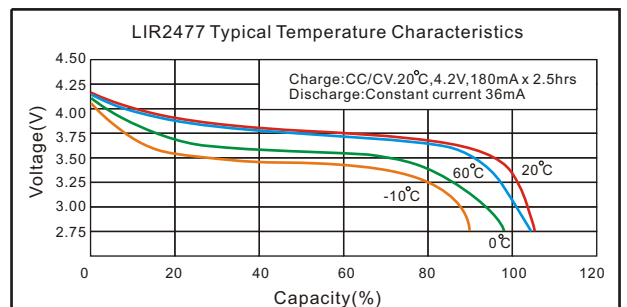

Note: Any representations in this brochure concerning performance, are for informational purposes only and are not construed as warranties either expressed or implied, of future performance.