

LIR2032 *Brief datasheet*

Lithium Ion Battery

1 Dimension

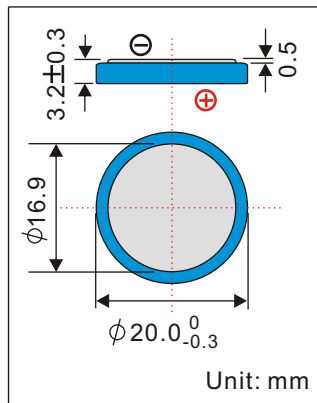

3 Electrical Characteristics

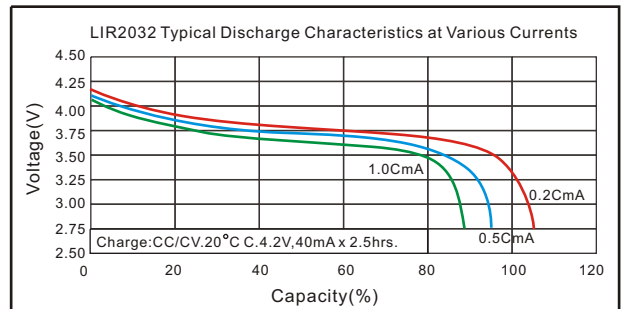

2 Basic Specification

Nominal Voltage		3.6V
Nominal Capacity	Typical	40mAh
	Minimum	35mAh
Charge method		CC/CV (Constant Current-Constant Voltage) current: 0.5C Voltage: 4.2V End current: 0.02C
Charging Voltage		4.20V
Charging Std. Current		0.5C
Max Current	Charge	1C
	Discharge	2C
Ambient Temperature	Std. Charge	-20°C to 45°C
	Discharge	-20°C to 60°C
	Storage	-20°C to 60°C
Discharge cut-off voltage		2.75V
Internal Impedance		≤600 mΩ
Cycle life		>500cycles(≥80% capacity)
Nominal Weight		Approx.3.1g

*1C = 1 Capacity

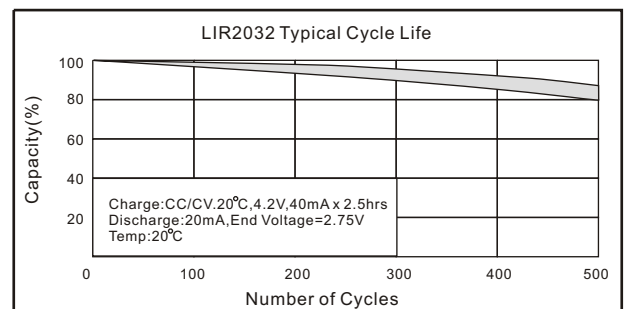
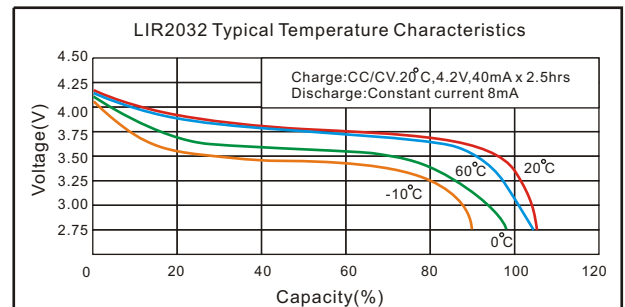

Note: Any representations in this brochure concerning performance, are for informational purposes only and are not construed as warranties either expressed or implied, of future performance.