

LIR14500 Lithium Ion Battery

Brief Datasheet

1 Dimension

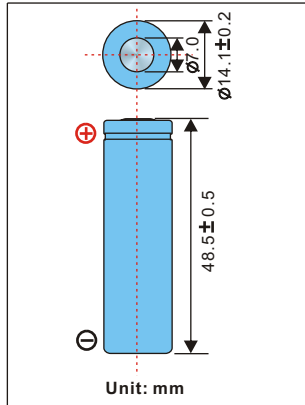

3 Electrical Characteristics

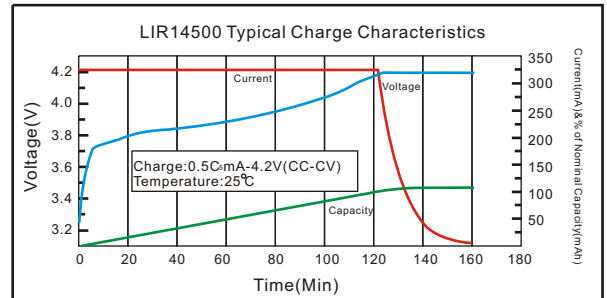

2 Basic Specification

Nominal Voltage	3.7V	
Nominal Capacity	Typical	750mAh (0.2C discharge)
	Minimum	750mAh (0.2C discharge)
Charge method	CC/CV (Constant Current-Constant Voltage) current:0.5C Voltage:4.2V End current: 15mA	
Charging Voltage	4.20V±0.05V	
Charging Std. Current	375mA	
Max Current	Charge	750mA
	Discharge	1500mA
Ambient Temperature	Std. Charge	-20°C to 45°C
	Discharge	-20°C to 60°C
	Storage	-5°C to 35°C
Discharge cut-off voltage	2.75V	
Internal Impedance	<80mΩ	
Cycle life	>300cycles(≥80% capacity)	
Nominal Weight	Approx.20g	

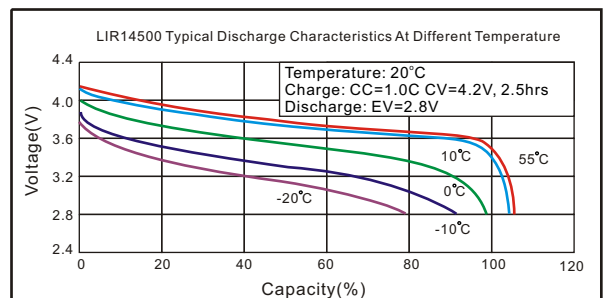
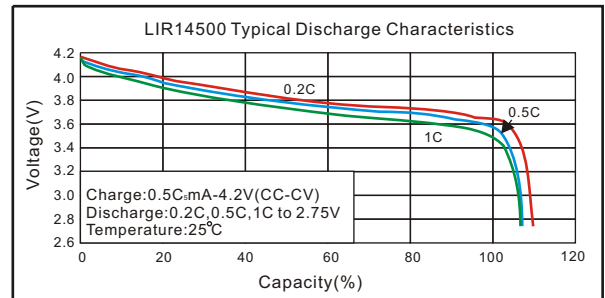

Note:*1C = 1 Capacity

Li-ion

Note: Any representations in this brochure concerning performance, are for informational purposes only and are not construed as warranties either expressed or implied, of future performance.